





EV3 SEALED AIR PRESSURE, BRAKE APPLICATION, AND RESERVIOR GAUGES AND SENSOR INSTALLATION INSTRUCTIONS



ICON KEY

-  **CAUTION**  Tools may be required  Shown in picture

1 PRESSURE SENSOR INSTALLATION

  **Disconnect batteries.** Do not reconnect battery power until system is fully configured to avoid risk of shock or fire.

2 Find a location where air pressure can be measured, such as a test port or a Tee fitting (from your local automotive supply store). This may require adapter fittings to accommodate the 1/8" NPT sensor threads.

3 Install the new sensor. Pressure sensor threads are 1/8" NPT.

 Many Emission Control Devices are connected to OEM sensors or switches. Be careful not to disable these when installing a sensor.

4 If leakage occurs at the sensor, tighten one-quarter turn at a time until leakage stops. If necessary, thread sealant such as Teflon tape may be used.

 When using a torque wrench, tighten approximately 1.69nm/15 lb-in. or slightly more if leakage occurs. Do not use the body of the sensor to tighten! Use only the hex and the correct wrench. Do not over tighten!

5 Plug harness into pressure sensor.



6 Route the pressure sensor harness' black, green and red/yellow wires to and through the firewall to the intended gauge location. Grommets usage is recommended.

7 GAUGE INSTALLATION

Connect the 6-pin sealed connector to the back of the gauge (with the gauge near its final mounting location), then route the sensor portion of the harness towards the firewall and the red, orange, black and brown wires with cut ends towards the fuse panel or other area where the power, dimmer, ground and optional output relay connections will be made, leaving enough length at the 6-pin connector to allow you to remove the gauge from the mount without unplugging it from the gauge.



Wires to be connected as follows:

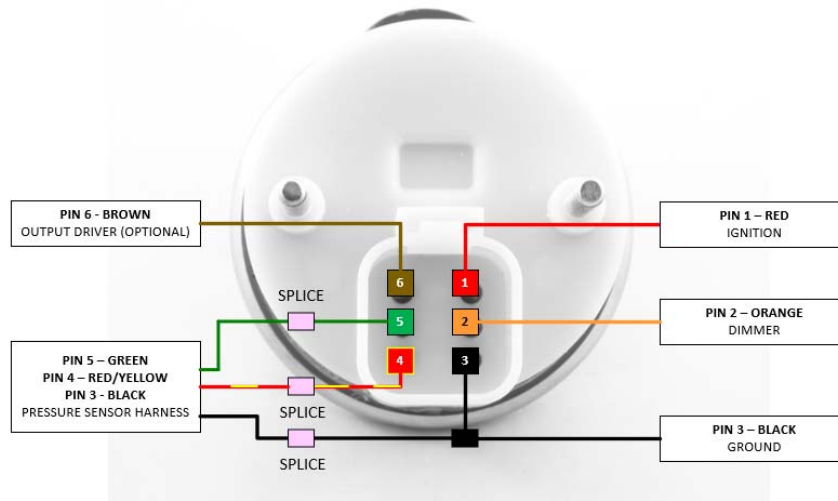

- **PIN 1 - Red:** [Ignition](#); Connect to one wire of the included fuse holder using the included crimp splice, and the other wire of the fuse holder connected to a circuit that switches on with the key switch. Install the included 1-amp fuse in the fuse holder.
 -  Use only 1-amp fuses, higher amperage fuses may cause damage to the gauge or to the vehicle.
- **PIN 2 – Orange:** [Dimmer](#); Connect the to the factory gauge dimmer circuit by either tapping into the in-cab fuse block or by connecting directly to the wire running from the dimmer on the headlight switch. **NOTE:** The gauge backlighting will only illuminate if both the ignition AND the dimmer circuits are on.
- **PIN 3 – Black:** [Ground](#); Connect 1 wire to clean ground on the vehicle such as the battery negative terminal or a factory ground bolt and splice the other to the black pressure sensor harness lead wire.
- **PIN 4 – Red/Yellow:** [Pressure Sensor](#); Splice to the Red/Yellow pressure harness wire
- **PIN 5 – Green:** [Pressure Sensor](#); Splice to the Green pressure harness wire
- **PIN 6 - Brown;** [Programmable Output Driver](#) can switch devices that draw up to 1.3 Amps (60V) so a 1A (1 Amp) fuse should be used. **Devices** include customer supplied Relay Coils, Solenoids, Warning Buzzers, and Lamps. These devices are not included in gauge kits. The Output Driver activates these devices at a programmed level. When wiring to polarized devices always wire pin 6 to the negative side of the device.

For battery connection: Wire pin 6 to one side of the **device (see above)** with the other side of the device wired to a positive battery connection fused for no more than 1A.

For ignition connection: Wire pin 6 to one side of the **device (see above)** with the other side of the device wired to a connection that switches on with the key switch fused for no more than 1A.

-  Secure all wiring so that it does not interfere with moving parts or chafe on sharp edges

10

EV3 ATTRIBUTE PROGRAMMER INSTALLATION

Android - Open the Google Play Store application. In the Search box, type “Attribute Programmer”. Select the **EV3 Attribute Programmer** from ISSPRO and install it on your device.

iOS (Apple) - Open the App Store. In the Search box, type “Attribute Programmer”. Select the **EV3 Attribute Programmer** from ISSPRO and install it on your device.

ONCE INSTALLED - APP INSTRUCTIONS ARE LOCATED IN “EXTRAS”